

60x60x25mm



- 产品系列 JC6025-02
Produce Series JC6025-02
- 扇叶材料 PBT 94V-0
Fan Blade Material PBT 94V-0
- 扇框材料 PBT 94V-0
Fan Frame Material PBT 94V-0
- 轴承结构 双滚珠(B)
Bearigng Structure Double ball bearing
- 工作温度 -20℃~70℃
Operation Temperature -20℃~70℃

型号 Model	电压 Reted voltage [V]	电流 Reted current [mA]	功率 Reted input [W]	转速 Reted speed [R. P. M]	风量 Air flow [CFM]	风压 Statc pressure [inchH2O]	噪音 Noise [dBA]
JC6025B12L	12	77	0.9	4800	21.7	0.240	33.2
JC6025B12M		190	2.3	6500	29.4	0.440	40.2
JC6025B12H		382	4.6	8200	37.1	0.680	46.0
JC6025B12S		652	7.8	9800	44.4	0.972	50.3
JC6025B12U		1088	13.1	12000	54.4	1.428	55.2
JC6025B24L	24	42	1.0	4800	21.7	0.240	33.2
JC6025B24M		105	2.5	6500	29.4	0.440	40.2
JC6025B24H		210	5.0	8200	37.1	0.680	46.0
JC6025B24S		359	8.6	9800	44.4	0.972	50.3
JC6025B24U		599	14.4	12000	54.4	1.428	55.2
JC6025B48L	48	23	1.1	4800	21.7	0.240	33.2
JC6025B48M		58	2.8	6500	29.4	0.440	40.2
JC6025B48H		116	5.5	8200	37.1	0.680	46.0
JC6025B48S		197	9.5	9800	44.4	0.972	50.3
JC6025B48U		329	15.8	12000	54.4	1.428	55.2

基本参数 Basic parameters

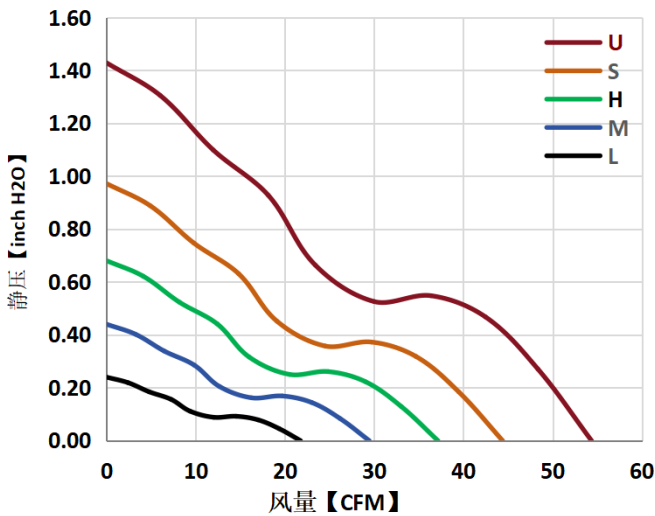

产品结构图 Outline

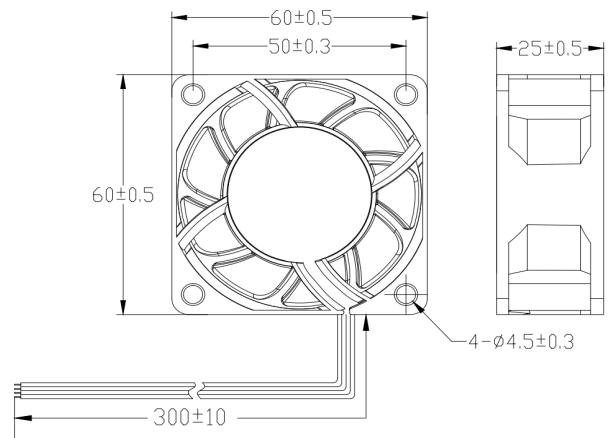

单位: mm

* 以上产品可选项 (转速/FG/RD/PWM) 及客制化设计需要求, 请与JENTECH销售联系
* 以上产品如有设计变更, 恕不另行通知, 请以规格承认书为准.