

92x92x38mm



- 产品系列 JC9238-01
Produce Series JC9238-01
- 扇叶材料 PBT 94V-0
Fan Blade Material PBT 94V-0
- 扇框材料 PBT 94V-0
Fan Frame Material PBT 94V-0
- 轴承结构 双滚珠(B)
Bearigng Structure Double ball bearing
- 工作温度 -20℃~70℃
Operation Temperature -20℃~70℃

型号 Model	电压 Reted voltage [V]	电流 Reted current [mA]	功率 Reted input [W]	转速 Reted speed [R. P. M]	风量 Air flow [CFM]	风压 Statc pressure [inchH2O]	噪音 Noise [dBA]
JC9238B12L	12	216	2.6	5800	82.4	0.746	48.9
JC9238B12M		526	6.3	7800	110.8	1.260	55.0
JC9238B12H		807	9.7	9000	127.8	1.588	59.2
JC9238B12S		1282	15.4	10500	149.1	2.141	63.1
JC9238B12U		1740	20.9	12000	170.4	2.663	67.3
JC9238B24L	24	119	2.9	5800	82.4	0.746	48.9
JC9238B24M		289	6.9	7800	110.8	1.260	55.0
JC9238B24H		444	10.7	9000	127.8	1.588	59.2
JC9238B24S		705	16.9	10500	149.1	2.141	63.1
JC9238B24U		957	23.0	12000	170.4	2.663	67.3
JC9238B48L	48	65	3.1	5800	82.4	0.746	48.9
JC9238B48M		159	7.6	7800	110.8	1.260	55.0
JC9238B48H		244	11.7	9000	127.8	1.588	59.2
JC9238B48S		388	18.6	10500	149.1	2.141	63.1
JC9238B48U		526	25.3	12000	170.4	2.663	67.3

基本参数 Basic parameters

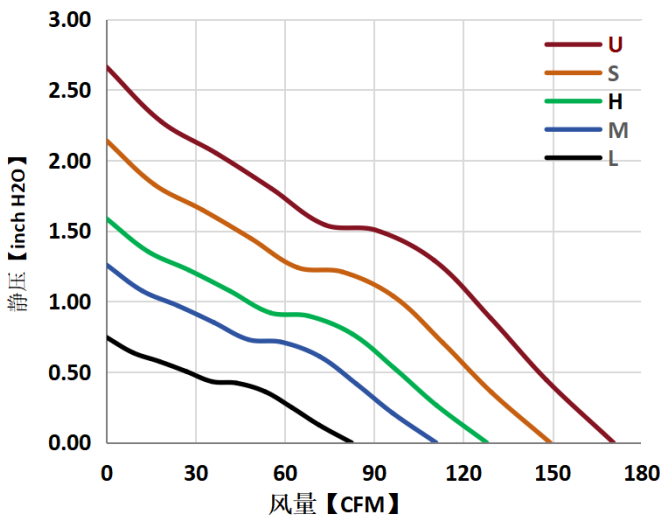

产品结构图 Outline

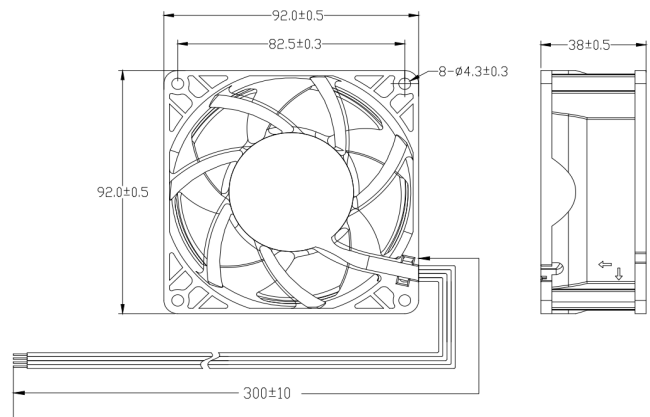

单位: mm

* 以上产品可选项 (转速/FG/RD/PWM) 及客制化设计需要求, 请与JENTECH销售联系
* 以上产品如有设计变更, 恕不另行通知, 请以规格承认书为准.