

60x60x25mm



- 产品系列 JC6025-01
Produce Series JC6025-01
- 扇叶材料 PBT 94V-0
Fan Blade Material PBT 94V-0
- 扇框材料 PBT 94V-0
Fan Frame Material PBT 94V-0
- 轴承结构 双滚珠(B)
Bearigng Structure Double ball bearing
- 工作温度 -20℃~70℃
Operation Temperature -20℃~70℃

型号 Model	电压 Reted voltage [V]	电流 Reted current [mA]	功率 Reted input [W]	转速 Reted speed [R. P. M]	风量 Air flow [CFM]	风压 Statc pressure [inchH2O]	噪音 Noise [dBA]
JC6025B12L	12	90	1.1	3800	20.9	0.186	33.5
JC6025B12M		206	2.5	5000	27.5	0.323	40.4
JC6025B12H		432	5.2	6400	35.3	0.529	46.7
JC6025B12S		782	9.4	7800	43.0	0.785	52.3
JC6025B12U		1244	14.9	9400	51.8	1.141	58.6
JC6025B24L	24	50	1.2	3800	20.9	0.186	33.5
JC6025B24M		113	2.7	5000	27.5	0.323	40.4
JC6025B24H		238	5.7	6400	35.3	0.529	46.7
JC6025B24S		430	10.3	7800	43.0	0.785	52.3
JC6025B24U		684	16.4	9400	51.8	1.141	58.6
JC6025B48L	48	27	1.3	3800	20.9	0.186	33.5
JC6025B48M		62	3.0	5000	27.5	0.323	40.4
JC6025B48H		131	6.3	6400	35.3	0.529	46.7
JC6025B48S		237	11.4	7800	43.0	0.785	52.3
JC6025B48U		376	18.1	9400	51.8	1.141	58.6

基本参数 Basic parameters

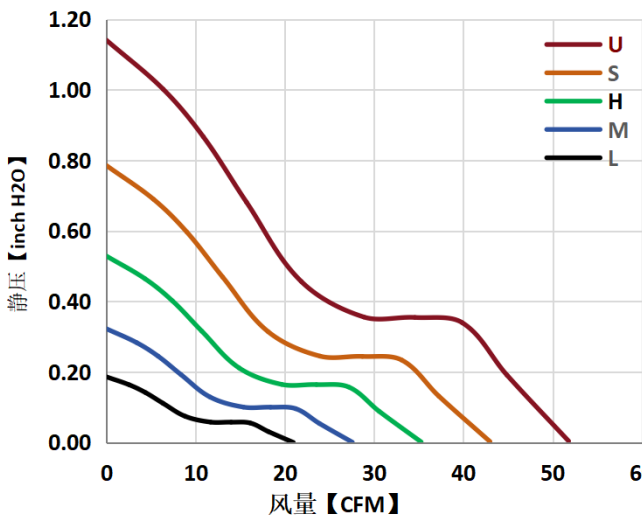

产品结构图 Outline

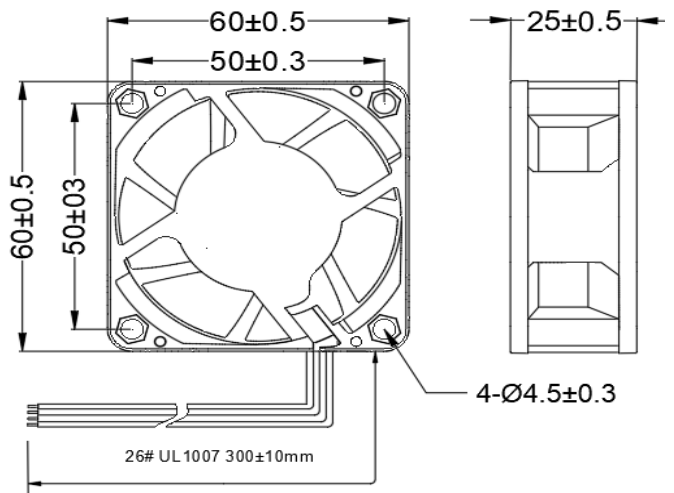

单位: mm

* 以上产品可选项 (转速/FG/RD/PWM) 及客制化设计需要要求, 请与JENTECH销售联系
* 以上产品如有设计变更, 恕不另行通知, 请以规格承认书为准.