

80x80x25mm



- 产品系列 JC8025-01
Produce Series JC8025-01
- 扇叶材料 PBT 94V-0
Fan Blade Material PBT 94V-0
- 扇框材料 PBT 94V-0
Fan Frame Material PBT 94V-0
- 轴承结构 双滚珠(B)
Bearigng Structure Double ball bearing
- 工作温度 -20℃~70℃
Operation Temperature -20℃~70℃

型号 Model	电压 Reted voltage [V]	电流 Reted current [mA]	功率 Reted input [W]	转速 Reted speed [R. P. M]	风量 Air flow [CFM]	风压 Statc pressure [inchH2O]	噪音 Noise [dBA]
JC8025B12L	12	120	1.4	3000	38.7	0.141	32.1
JC8025B12M		149	1.8	3800	49.1	0.222	37.8
JC8025B12H		280	3.4	4600	59.4	0.326	42.9
JC8025B12S		542	6.5	5600	72.3	0.483	48.4
JC8025B12U		649	7.8	6400	80.2	0.624	53.3
JC8025B24L	24	66	1.6	3000	38.7	0.141	32.1
JC8025B24M		120	2.9	3800	49.1	0.222	37.8
JC8025B24H		154	3.7	4600	59.4	0.326	42.9
JC8025B24S		298	7.2	5600	72.3	0.483	48.4
JC8025B24U		357	8.6	6400	80.2	0.624	53.3
JC8025B48L	48	36	1.7	3000	38.7	0.141	32.1
JC8025B48M		66	3.2	3800	49.1	0.222	37.8
JC8025B48H		85	4.1	4600	59.4	0.326	42.9
JC8025B48S		164	7.9	5600	72.3	0.483	48.4
JC8025B48U		196	9.4	6400	80.2	0.624	53.3

基本参数 Basic parameters

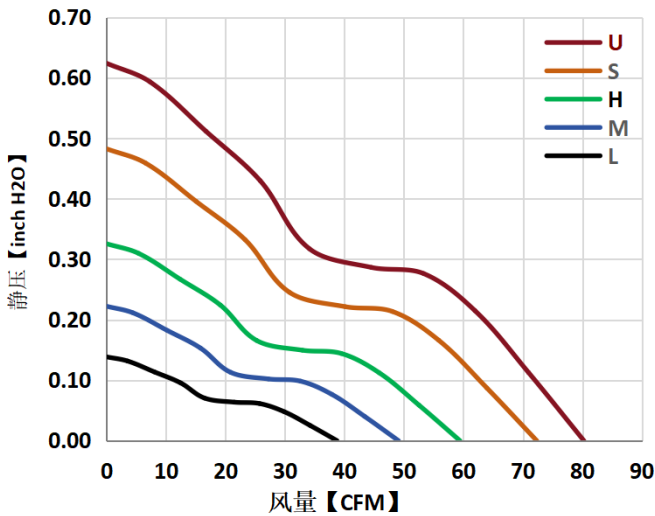

产品结构图 Outline

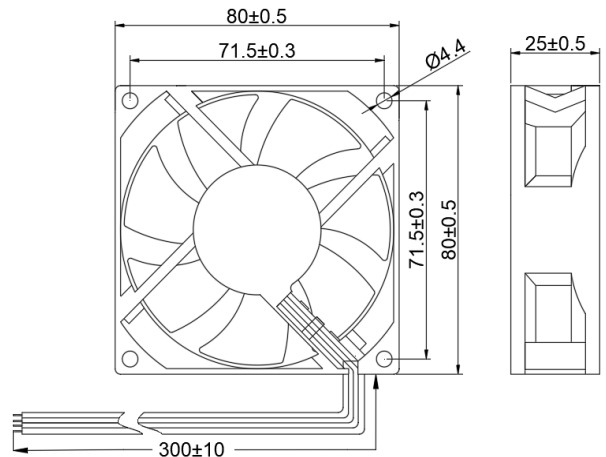

单位: mm

* 以上产品可选项 (转速/FG/RD/PWM) 及客制化设计需要要求, 请与JENTECH销售联系
* 以上产品如有设计变更, 恕不另行通知, 请以规格承认书为准.